

SPAR-Logistics Handbook for supplieres

Assortment: Fruit and Vegetables

Version: January 2024

History of changes

Version	Changes	Page
January 2024	Changed contact information	Page 4& 6
September 2023	Changed contact information	Page 7
	Added Arrival times UFC	Page 13
	Charges of additional expenses - Frutura	Page 14
	Delivery in Reuseable Cases	Page 20
	Placement of Palletlabel	Page 26
May 2023	Adjustment of amount billed	Page 24
	Adjustment of amount billed	Page 28

Table of Contents:

1. [New Suppliers](#)
2. [Delivery Process in all SPAR Warehouses](#)
 - [2.1 Details Warehouse Dornbirn](#)
 - [2.2 Details Warehouse - Wörgl](#)
 - [2.3 Details Warehouse - Marchtrenk](#)
 - [2.4 Details Warehouse – St. Pölten](#)
 - [2.5 Details Warehouse – Ebergassing](#)
 - [2.6. Details Warehouse – Graz](#)
 - [2.7 Details Warehouse – Maria Saal](#)
3. [Conditions for Delivery Processing](#)
 - [3.1 Loading Aids](#)
 - [3.2 Pallet Quality](#)
 - [3.3 Pallet Goods-Shifting](#)
 - [3.4 Pallet Heights](#)
 - [3.5 Pallet Weight](#)
 - [3.6 Delivery in Reuseable Cases](#)
 - [3.7 Condition of the pallet](#)
 - [3.8 Pickup of returned goods](#)
 - [3.9 Delivery note](#)
4. [Labelling](#)
 - [4.1 Pallet Labelling](#)
 - [4.2 Examples of Delivery Notes \(DIN A5\)](#)
 - [4.3 Placement of the pallet labels](#)
 - [4.4 Product Labelling](#)
 - [4.5 Barcode quality](#)
5. [Electronic Data Interchange with SPAR](#)
6. [Safety measurements at Goods Receiving](#)

1. New Suppliers

- In order to avoid any problems in advance, please contact the Logistics Department prior to the first delivery.
- Contact:
 - SPAR Österr. Warenhandels AG, Salzburg, Europastr. 3, A-5015 Salzburg:
 - Fabian Eßl, MA
 - Tel.: +43 664 8874 8668
 - E-Mail: fabian.essl@spar.at
- Additionally, the registration on our B2B Portal is necessary (<http://b2b.spar.at>). There you also always find the latest version of our logistics handbook.

Delivery Process in all SPAR Warehouses

Goods Arrival:

The goods arrival can occur by truck in all SPAR Warehouses. The goods arrival by bus, car or any other small vehicle is not allowed and will lead to a rejection of the delivery.

Standard Delivery Condition for all regional Warehouses:

Delivery by truck behind first free lockable door or if existing onto the free conveyor equipment (Furthermore the SPAR Company general terms of delivery apply). For the unloading of the goods the suppliers will be supplied with manual pallet lifters, electrical pallet lifters and double-pallet fork-lift trucks.

Punctuality of Deliveries:

All delivery dates, which are agreed with SPAR, must be met. Trucks, which arrive on the wrong date, can be rejected by the goods arrival.

In order to guarantee a punctual unloading at the SPAR warehouses and to avoid stand by times, there is the possibility of time slot reservation with MERCAREON time slot management. Via the MERCAREON internet portal delivering carriers have the possibility to view the available time slots for a specific delivery and to book the most adequate slot. Please find more information at www.mercareon.com.

2.1 Details Warehouse - Dornbirn

SPAR Österr. Warenhandels AG, Dornbirn

Delivery Area	Vorarlberg
Anschrift	Wallenmahd 46, A-6850 Dornbirn
GLN	91 00010 00000 5
Acronym	ZN 01

Contact Information

Name	Phone-Number	E-Mail
Sabrina Eibl	+43 5572 309 31591	sabrina.eibl@spar.at



Goods Arrival Times

Montag-Freitag	05:00-08:00
Samstag	Closed
Sonntag	05:00-08:00



2.2 Details Warehouse - Wörgl

SPAR Österr. Warenhandels AG, Wörgl

Delivery Area Tirol und Salzburg

Anschrift SPAR-Straße 1, A-6300 Wörgl
Acces only via Nordtangente, not the city center!

GLN 91 00020 00000 2

Acronym ZN 02

Contact Information

Name	Phone-Number	E-Mail
Yvonne Hager	+43 664 88984878	Yvonne.HAGER@spar.at



Goods Arrival Times

Sonntag-Freitag

02:00-06:00



2.3 Details Warehouse - Marchtrenk

SPAR Österr. Warenhandels AG, Marchtrenk

Delivery Area	Oberösterreich
Anschrift	Sparstraße 1, A-4614 Marchtrenk
GLN	91 00030 00000 9
Acronym	ZN 03

Contact Information

Name	Phone-Number	E-Mail
Lukas Greifeneder	+43 7243 551 33501	lukas.greifeneder@spar.at



Goods Arrival Times

Montag-Freitag	03:00-06:00
Samstag	Closed
Sonntag	03:00-06:00



2.4 Details Warehouse – St. Pölten

SPAR Österr. Warenhandels AG, St. Pölten

Delivery Area	Niederösterreich, Wien, nördliches Burgenland
Anschrift	Lagergasse 30, A-3100 St. Pölten
GLN	91 00040 00000 6
Acronym	ZN 04N

Contact Information

Name	Phone-Number	E-Mail
Thomas Gessner	+43 2742 866 345325	thomas.gessner@spar.at



Goods Arrival Times

Samstag-Freitag	22:00-06:00
-----------------	-------------

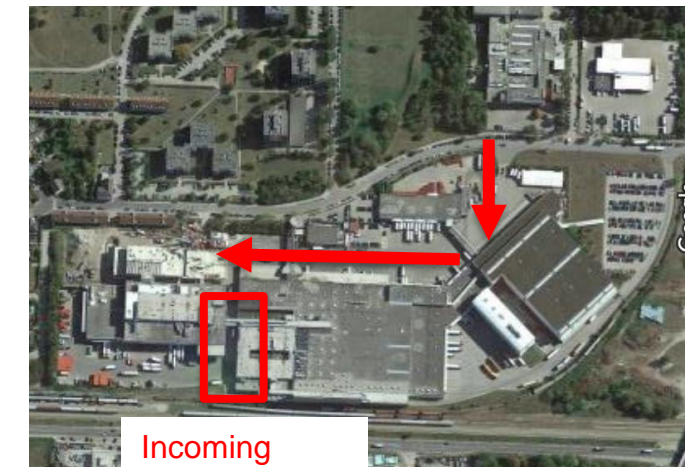

Incoming
Goods area

2.5 Details Warehouse – Ebergassing

SPAR Österr. Warenhandels AG, Ebergassing

Delivery Area	Wien und nördliches Burgenland
Anschrift	SPAR Straße 1, A-2435 Ebergassing (Delivery rout threw city-center forbidden!)
GLN	91 00041 00000 5
Acronym	ZN 04W

Contact Information

Name	Phone-Number	E-Mail
Patrick Hörmann	+43 2234 7220030530	Patrick.Hoermann@spar.at



Goods Arrival Times

Montag-Freitag	22:00-05:00
Samstag	22:00-05:00
Sonntag	22:00-05:00



2.6. Details Warehouse – Graz

SPAR Österr. Warenhandels AG, Graz

Delivery Area	Steiermark und südliches Burgenland
Anschrift	Hafner Straße 20, A-8055 Graz (Delivery only via street "Schwarzer Weg"!)
GLN	91 00050 00000 3
Acronym	ZN 05

Contact Information

Name	Phone-Number	E-Mail
Andrea Götschl	+43 316 248 35512	Andrea.goetschl@spar.at



Goods Arrival Times

Montag-Freitag	01:00-07:00
Samstag	Closed
Sonntag	00:00-06:30



2.7 Details Warehouse – Maria Saal

SPAR Österr. Warenhandels AG, Maria Saal

Delivery Area	Kärnten und Osttirol
Anschrift	Sparstraße 1. 9063 Maria Saal
GLN	91 00060 00000 0
Acronym	ZN 06

Contact Information

Name	Phone-Number	E-Mail
Rene Schweighofer	+43 4223 5000 36590	Rene.schweighofer@spar.at



Goods Arrival Times

Montag-Freitag	04:00-08:00
Samstag	04:00-08:00
Sonntag	04:00-08:00



2.8 Arrival times UFC

Shortened goods arrival times apply to convenience and ultra-fresh products (e.g.: cut fruit and vegetables) in the fruits and vegetables assortment.

Please refer to the table below for details:



	Monday	Tuesday	Wednesday	Thursday	Friday	Saturday	Sunday
ZN01 – Dornbirn	5-7 o'clock	5-7 o'clock	5-7 o'clock	5-7 o'clock	5-7 o'clock	x	4-5 o'clock
ZN02 – Wörgl	1-5 o'clock	1-5 o'clock	1-5 o'clock	1-5 o'clock	1-5 o'clock	x	1-5 o'clock
ZN03 – Marchtrenk	3-6 o'clock	3-6 o'clock	3-6 o'clock	3-6 o'clock	3-6 o'clock	3-6 o'clock	3-6 o'clock
ZN04N – St. Pölten	22-3 o'clock	22-3 o'clock	22-3 o'clock	22-3 o'clock	22-2 o'clock	22-2 o'clock	22-3 o'clock
ZN04W – Ebergassing	20-2 o'clock	20-2 o'clock	20-2 o'clock	20-2 o'clock	20-2 o'clock	x	x
ZN05 – Graz	22-4 o'clock	22-4 o'clock	22-4 o'clock	22-4 o'clock	22-4 o'clock	22-4 o'clock	1-2 o'clock
ZN06 – Maria Saal	3-8 o'clock	3-8 o'clock	3-8 o'clock	3-8 o'clock	3-8 o'clock	x	3-8 o'clock

Conditions for Delivery Processing

All listed requirements for logistics processing are also valid for our partner Frutura, since processes are partly performed at the Frutura warehouses. Therefore, Frutura is also entitled to the settlement of additional expenses incurred.

3.1 Loading Aids

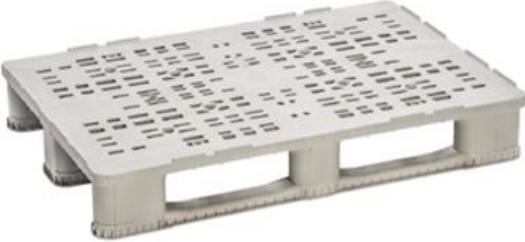
Accepted Loading Aids:

IFCO-Palette (B1208A)	CHEP-Paletten (B1208A)	EURO-Paletten (Nach DIN EN 13698-1)
		
<p>As loading aids SPAR prefers the use of the IFCO pallet (Endur E7) with the overall dimensions of 1200 mm x 800 mm. In this rental system, there is no pallet exchange. The empty pallets are collected directly from the regional warehouses by employees of the IFCO company for redistribution.</p>	<p>As loading aids SPAR also accepts the use of the CHEP Euro pallet (B1208A) with the overall dimensions of 1200 mm x 800 mm. In this rental system, there is no pallet exchange. The empty pallets are collected directly from the regional warehouses by employees of the CHEP company for redistribution.</p>	<p>As a further loading aid SPAR accepts the Europool Pallet (DIN EN 13698-1). They are processed as described below (Pallet and Poolcase Processing). Generally the pallets and poolcases are processed by exchange. This means that the supplier receives the same amount of exchanged pallets/poolcases as those delivered. One-way, Düsseldorf and Overseas pallets are not exchanged.*</p>

SPAR does not accept other loading aids. If the loading aid does not comply with the above-mentioned loading aid, SPAR will charge the supplier for the costs incurred for changing the loading aid (EUR 20.- per pallet).

*Exceptions to the Rule:

- Should there, in exceptional cases, not be enough empty pallets/poolcases for an exchange with the supplier, SPAR will retain the pallets/poolcases as a gratuitous loan from the supplier. The truck driver will receive a confirmation with which the reclaim can be asserted. Reclaiming pallets/poolcases is possible at any time during the following three months as soon as the original confirmation is produced. This rule is only applicable at the relevant Regional Warehouse.
- For reasons of accounting and stock keeping confirmations older than three months can not be redeemed. The possibility to reclaim will expire after three months.
- Should the exchange not be possible on the part of SPAR, the confirmation will be extended for further three months.

3.2 Pallet Quality

SPAR will not accept or exchange pallets on which:

1. a board is missing, or broken either diagonally or straight across
2. a base or decking is so damaged or splintered that a nail or a screw is projecting
3. a block is missing or broken or so splintered that screws or nails are visible.
4. there is not at least one identification symbol (EUR and pool-keeper logo) on each long side that is legible.
5. the general condition is so bad that the load - bearing capacity is not guaranteed or where the loaded goods could be damaged or soiled.

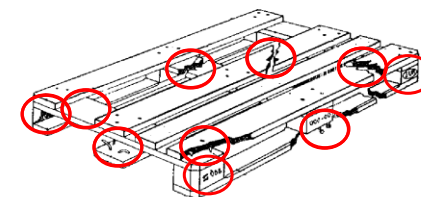

Attention:

An optimal quality of pallets enables an efficient flow of goods in the whole supply chain. In case of a poor pallet quality entry on material-handling equipment is not possible, the risk of breakage is high and goods and in the worst-case consumers can be harmed by wooden splinters, projecting nails and extraordinarily dirty pallets.

Deliveries on poor quality pallets can be rejected by goods receiving, in order to accelerate the goods receiving process.

If the pallets don't meet the SPAR criteria, the supplier will be charged the additional work (EUR 20.- per pallet).

That is also valid for CHEP Pallets, which are distributed over cheaper rental models like the pickup from wholesalers. Such models can lead to a poorer CHEP pallet quality, because of not every pallet being checked and repaired at the CHEP service center. Due to cost and environment reasons this is of course reasonable, but it must not lead to a bad pallet quality. Therefore, every supplier has to check the pallet quality prior to sending, otherwise additional expenses occur in the goods arrival. In case of an accumulation of damaged CHEP pallets we will charge it.

The number of defective pallets and the signature of the goods receiving personnel on the bill of delivery serve as a proof. SPAR has no burden of proof by photographs.

The number of defective pallets and the signature of the goods receiving personnel on the bill of delivery serve as a proof. SPAR has no burden of proof by photographs.

3.3 Pallet Goods-Shifting

No Pallet Shifting Before Transportation

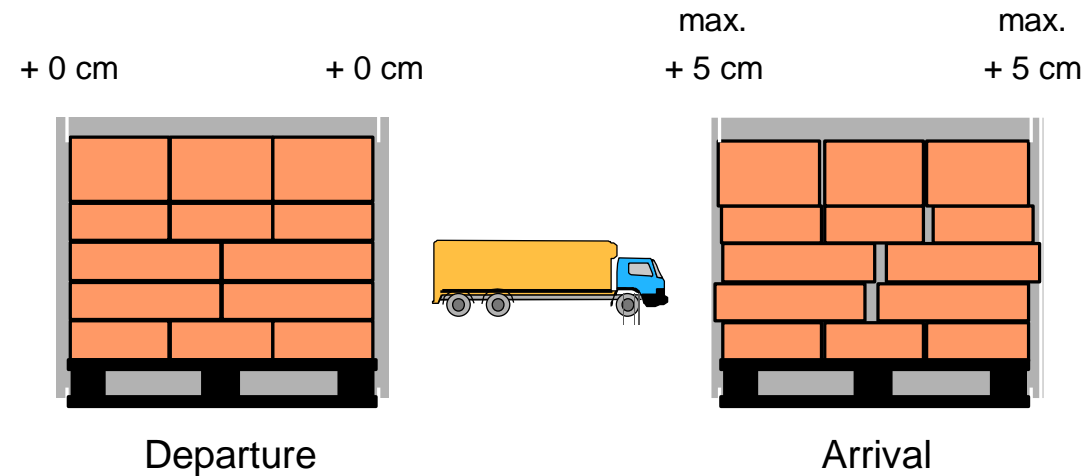

Upon arrival the pallet shifting must not be more than 5cm.

3.4 Pallet Heights

All warehouses are equipped according to EUL pallet heights.

The pallet heights are:

ECR-Name	EUL-Overall heights incl. Pallet	
EUL 2	2250 mm	2100 mm product + 150 mm pallet
EUL 1,4	1620 mm	1470 mm product + 150 mm pallet
EUL 1	1200 mm	1050 mm product + 150 mm pallet
EUL ½	675 mm	525 mm product + 150 mm pallet
EUL ⅓	500 mm	350 mm product + 150 mm pallet

Should the gross weight of the wholesale packaging unit constitute less than 12 kg, the pallet height may range up to 2,4 m. Should this weight be exceeded, the maximum height of the pallet is 2,15 m. Should the maximum pallet height of 2,4 m respectively 2,15 m be exceeded, SPAR reserves the right to charge 10 Euros per pallet.

3.5 Pallet Weight

The total weight of a pallet may not exceed **1000 kg**.

3.6 Delivery in Reuseable Cases

- SPAR insists on the delivery of IFCO-Reusable Cases (if not stipulated differently with the SPAR-sortiments manager).
- **Billing of IFCO Cases:**
 - Deposit-free procedure between supplier and SPAR (as found in the guidelines of the deposit-free circulation incl. forms and reports).
- **Booking of the delivered IFCO-cases quantity in the IFCO Web Clearing portal**
 - The quantities of the delivered IFCO-cases have to be booked in time in the IFCO Web Clearing portal. The IFCO cases are part of the delivery, therefore the booking in the portal has to be done at the time of delivery by the latest.
 - Every delay leads to additional work so that SPAR reserves the right to charge all suppliers, who have booked the delivered IFCO-cases late in time 25 Euros per delivery.
- **BEWARE: SPAR ONLY ACCEPTS GOODS IN CLEAN CASES!**
- Should the delivery not be in clean cases the following consequences apply:
 1. Goods are not taken over
 2. If the goods are taken over, the supplier will be charged EUR 0,51/case. Should SPAR be charged for dirty cases, this charge will be passed on to the supplier.
- The collection of reusable cases must be coordinated with the responsible contact persons in the regional warehouse. An agreed collection date must be held and may only be changed with the consent of the warehouse.

3.7 Condition of the pallet

- The goods must be stacked as one product per pallet, if the ordered quantity is at least one layer. However, intermediate pallets can be stacked on top of each other.
- Products, in danger of falling off, through transportation by truck, rail or in the warehouse, must be secured with Transport protection (Plastic film or a safety strap). If a plastic film is used, it must not be black.
- All boxes on a pallet must have the same best before date and the same batch number.
- As defined by IFS-Logistics the product safety is a must. That's why a carton must be put between the pallet and goods in easily damageable packaging. This way damaging trough splinters and other sharp items can be avoided and the product safety is guaranteed.

If the condition of the pallet is not conform with the above requirements, SPAR charges the additional expenses of EUR 20,- per pallet.

3.8 Condition of the picking unit

- The goods must be in perfect condition. This means no damaged or soiled goods etc.
- The delivery unit must be a closed, compact unit which permits stacking in any position on our roll cages (the goods must not fall out of the packaging).
- The lid may not detach from the carton when lifting (banderols, glue spots, etc.).
- The barcode must be easily found and may not be attached to the lower side of the unit.
- Heavy goods (especially tin cans and glasses) must be shrinked in foil.
- When Shelf Ready Packaging is applied, the unit should be at least as stable for it to permit efficient handling in the warehouse (Glue to stabilise, banderols etc.).
- The size of the wholesale packaging unit (WPU) should be adjusted to the size of the retail packaging unit in order to prevent damage.
- It is not permitted to pack several WPUs in an overpackaging. One unit must be one move.

If the condition of the picking unit is not conform with the above requirements, SPAR charges the additional expenses of EUR 0,5,- per picking unit.

3.9 Pickup of returned goods

- In case SPAR is refusing the goods arrival due to quality issues, the goods have to be taken immediately back to the supplier. If the goods are not taken back until 36 hours after the delivery, they will be littered at the cost of the supplier. In exceptional cases, which are pronounced to the suppliers, the goods have to be taken back immediately after the goods arrival..

3.10 Delivery note

- For a proper goods arrival in our warehouses SPAR needs a correct delivery paper (delivery note, CMR), on which the SPAR order number must be quoted. For each SPAR order-number a delivery note must be handed over to the bureau of the goods arrival.
- If the SPAR order number is missing on the delivery note/CMR, the delivery note is missing or just placed on the goods or more than one SPAR order number is quoted on the delivery note, SPAR reserves the right to charge the supplier EUR 25,-. A delivery note isn't necessary, if all relevant information is noted on the CMR.

Labelling

Please send us a sample label (pallet and WPU) prior to the first delivery for testing!

In case you are generating a GS1 barcode for the first time, please contact the GS1 institution of your country, to fulfil all requirements.

Warehouse suppliers to:

SPAR Österr. Warenhandels AG

Zweigniederlassung St. Pölten

Lagergasse 30, 3106 St.Pölten-Spratzern

Thomas Gessner, Tel. +43 2742 866 345325

thomas.gessner@spar.at

Additional Information can be found at <http://www.gs1.at>.

Contact GS1

GS1-Austria

Brahmsplatz 3, 1040 Wien

Gerald Gruber, Tel: +43 1 505 8601 43

E-Mail: gruber@gs1.at

4.1 Pallet Labelling

SPAR requires the labelling of all pallets with the GS1-128+SSCC pallet label.

If the GS1:128 and the SSCC are missing or are encoded falsely, SPAR will charge the supplier EUR 5.5 per pallet.

Data Content:

- SSCC - Number of the pallet AI (00)
- the GTIN-Number of the secondary packaging (Wholesale P U) AI (02)*
- the date of packaging – if available AI (13)
- the best before date – if available AI (15)
- the batch number – if available AI (10)
- amount of secondary packaging (WPU) on the pallet AI (37)

*The GS1-128+SSCC label must comprise the WPU GTIN which was agreed on with SPAR. Displaying other GTINs, for example the GTIN Number of the over packaging is not permitted.

Module width / Barcode height:

Width: 0,495 – 1,016 mm

Height: 32 mm

Sticker/Label format (Recommendation):

DIN A5 210 x 148 mm (H x W)

DIN A6 148 x 105 mm (H x W)

4.2 Examples of Delivery Notes (DIN A5)

Musterunternehmen

SSCC: **391000000000000375**

CONTENT
(GTIN der Handelseinheit): **9012345000028**

COUNT
(Menge der Handelseinheiten): **120**

PACK DATE, dd.mm.yyyy
(Packdatum): **17.05.2023**

BATCH/LOT
(Los/Charge): **A1234**

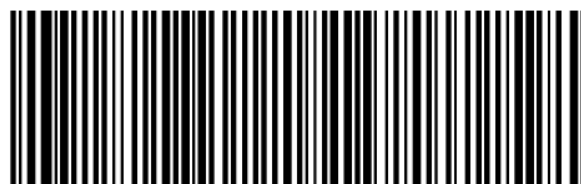

(02)09012345000028(13)230517(37)0120



(00)391000000000000375(10)A1234

Version 3.8, www.gs1.at

4.3 Placement of the pallet labels

- According to the ECR handbook, the GS1 transport-label must be applied 400 - 800mm from the floor and at least 50 mm from the side. On transport secured pallets the sticker must be attached to the plastic film. One label must be applied on the narrow side and one on the long side to the right hand side of it.
- For better processing in our warehouses, we would like to ask you to attach the pallet label as far right as possible. This allows us an optimal handling at every move of the pallet.
- On low pallets it is allowed to bend the text field over the edge onto the top. The barcode part must be scan able without any further manipulation (ECR documentation „Harmonisierung GS1-128 – GS1 Transportetikett“).
- For whole and layer pallets, the pallet label must be applied on the outside of the pallet film. For mixed pallets, the pallet label must be applied on the inside (print side of the label facing forward) of the pallet film.

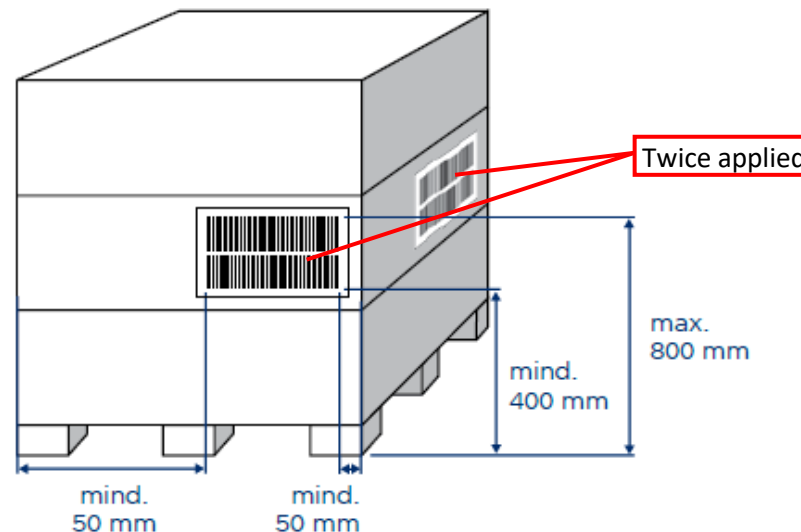

4.3 Placement of the pallet labels

- Please attach this pallet destination note on every SPAR pallet. You can download the label under
 - https://b2b.spar.at/imperia/md/content/b2b_spar_at/spar_palettenzettel_pallet_destination_note.xls

SPAR Lager/ Frutura Drehscheibe	ZN01 Dornbirn	ZN02 Wörgl	ZN03 Marchtrenk	ZN04N St. Pölten	ZN04W Ebergassing	ZN05 Graz	ZN06 Maria Saal	Frutura Hartl	Frutura Sattledt
SPAR Warehouse/Magazzino/Almacén Frutura Warehouse/Magazzino/Almacén					X				
Anlieferungsdatum SPAR Österreich								Sonntag, 05. Juli 2020	
Delivery date/Data di consegna/Fecha de entrega									
Lieferant Supplier/Fornitore/Proveedor	Musterlieferant						Anzahl GVE pro PAL Cartons per pallet/Colli per PLT/Cartones	60	
Artikel Article/Articolo/Artículo	Zucchini 500g						Anzahl PAL Number of pallets/Totale PLT/Cantidad de	12	
SPAR-Bestellnummer SPAR Order number/Numero ordine/Número de pedido	450...						PAL Nr. Pallet number/PLT numero/Palet número	von of/di/de	12
Frutura-Bestellnummer Frutura Order number/Numero ordine/Número de pedido	410...						1		
Transporttemperatur Transport temperature/Temperatura di trasporto/ Temperatura de transporte								4°C	10°C
									X

4.4 Product Labelling

WPU (Wholesale -Packing-Unit)

The secondary packaging should always include a GS1-128 Label.

The content must be clearly and visibly stated. This facilitates the allocation of the goods to the bill of delivery.

The following topics are important for proper labelling.

Data Content:

- the GTIN-Number of the secondary packaging (Wholesale P U) AI (01)
- the packaging date or best before date* AI(13) or AI (15)

*Articles **without** best before date need to have the AI 13 encoded in the product and pallet labelling. Articles **with** best before date need to have the AI 15 encoded in the product and pallet labelling.

Placement of the GS1-128 Label

In case of **IFCO cases and carton packaging** the etiquette has to be placed on the short side. All etiquettes must face the same direction, to avoid additional searching.

Should the labelling according to GS1-128 standards be missing or be falsely encoded, SPAR will charge the supplier a surcharge of EUR 0.40 per unit.

4.5 Barcode quality

In order to ensure fast and efficient scanning processes at the cash registers and in SPAR wholesale-fulfillment centers, the following quality requirements of the barcodes are needed:

The attached bar code symbol must have at least the following overall symbol class according to **ISO / IEC 15416**:

The attached barcodes must have an overall symbol class of at least **1.5** according to ISO / IEC 15416 (test specification for barcode quality), the barcode must also correspond to the respective specifications of the barcode symbology.

To ensure optimal readability of the barcodes, SPAR recommends an overall symbol **classification of 2.5**.

For your information: A barcode can be rated between 0 and 4 with a test device. According to ISO / IEC 15416 a rating of 4 is the best value. The check can be carried out by an GS1 organization such as GS1 Austria (www.gs1.at/strichcodepruefservice).

Electronic Data Interchange with SPAR

SPAR provides the possibility of interchanging data electronically. The supported messages are orders, Despatch Advice (for warehouses and direct deliveries) and Invoic.

In our Warehouses we set a high value into the DesAdv. This electronic message enables precise planning and processing at the goods receiving and thus accelerates the process. This results in shorter waiting times.

Therefore, we expect our partners to transmit electronic bills of deliveries which accord to todays standards.

BEWARE! In order to use DesAdv's, the correct use of the GS1-128 label on the pallets is absolutely necessary.

Information on the composition of Despatch Advices can be found on our B2B Portal using the following [Link](#) or by accessing threwh the B2B-portal (<http://b2b.spar.at>).

In the Warehouses we require the hierarchical DesAdv incl. SSCC.

If the transferred data (expiry date, quantity and batch) from the DesAdv is not correct or the whole DesAdv is missing, SPAR charges the additional expenses of EUR 100,-.

Safety measurements at Goods Receiving

Warehouse Premises

- Driving with an open auto hoist on SPAR warehouse premises is forbidden.
- The road transport regulation is applicable on warehouse premises, with a maximum speed of 10 km/h and keeping to the right. Please beware of human traffic.
- The parking of vehicles is only permitted in the designated areas and only until unloading.

Goods receiving

- Follow the instructions of the goods receiving personnel.
- Access is only granted to the goods receiving area. All other areas of the warehouse may only be accessed when permitted.
- Before unloading the supplier has to register with the responsible goods receiving and show bill of lading and bill of delivery.
- The automatic lifting ramps are to be operated accordingly. Should the truck driver have no experience with these he must announce this to the SPAR personnel who will brief him.
- The unloading has to be carried out by the supplier.
- The unloading is only permitted with safety shoes.
- Should the pallet quality not comply with the standards of SPAR, the pallet will not be exchanged.



Safety measurements at Goods Receiving

General

- The handling of SPAR owned electronic devices takes place at the users' risk. The supplier is liable for all damage occurred. Accidents and damage are to be announced to the goods receiving supervisor immediately and a report of the accident has to be written.
- All waste has to be removed accordingly.
- Smoking in the hall and the drinking of alcoholic beverages everywhere on the warehouse premises are strictly forbidden.
- Beware of frequent traffic with electronic devices at goods receiving.
- In case of a fire alarm, obey the instructions of SPAR personnel.
- Emergency exits have to be free at every time.

